

◆ ◆ ◆ ◆ ◆
◆ ◆ ◆ ◆ ◆
Instruction manual
◆ ◆ ◆ ◆ ◆
◆ ◆ ◆ ◆ ◆

**CANopen® slave interface
for digital multibus
Mass Flow / Pressure instruments**

Doc. no.: 9.17.131B Date: 03-12-2019

◆ ◆ ◆ ◆ ◆
◆ ◆ ◆ ◆ ◆
◆ ◆ ◆ ◆ ◆
◆ ◆ ◆ ◆ ◆
ATTENTION

Please read this instruction manual carefully before installing and operating the instrument.
Not following the guidelines could result in personal injury and/or damage to the equipment.

Disclaimer

The information in this manual has been reviewed and is believed to be wholly reliable. No responsibility, however, is assumed for inaccuracies. The material in this manual is for information purposes only.

Copyright

All rights reserved. This documentation is protected by copyright. Subject to technical and optical changes as well as printing errors. The information contained in this document is subject to change at any time without prior notification. Bronkhorst High-Tech B.V. reserves the right to modify or improve its products and modify the contents without being obliged to inform any particular persons or organizations. The device specifications and the contents of the package may deviate from what is stated in this document.

Symbols



Important information. Discarding this information could cause injuries to people or damage to the instrument or installation.



Helpful information. This information will facilitate the use of this instrument.



Additional info available on the internet or from your local sales representative.

Warranty

Bronkhorst® products are warranted against defects in material and workmanship for a period of three years from the date of shipment, provided they are used in accordance with the ordering specifications and the instructions in this manual and that they are not subjected to abuse, physical damage or contamination.

Products that do not operate properly during this period may be repaired or replaced at no charge. Repairs are normally warranted for one year or the balance of the original warranty, whichever is the longer.



See also paragraph 9 of the Conditions of sales:

http://www.bronkhorst.com/files/corporate_headquarters/sales_conditions/en_general_terms_of_sales.pdf

The warranty includes all initial and latent defects, random failures, and undeterminable internal causes.

It excludes failures and damage caused by the customer, such as contamination, improper electrical hook-up, physical shock etc.

Re-conditioning of products primarily returned for warranty service that is partly or wholly judged non-warranty may be charged for.

Bronkhorst High-Tech B.V. or affiliated company prepays outgoing freight charges when any party of the service is performed under warranty, unless otherwise agreed upon beforehand. However, if the product has been returned collect to our factory or service centre, these costs are added to the repair invoice. Import and/or export charges, foreign shipping methods/carriers are paid for by the customer.

Table of contents

1	GENERAL PRODUCT INFORMATION	4
1.1	INTRODUCTION	4
1.2	REFERENCES TO OTHER APPLICABLE DOCUMENTS	4
1.2.1	<i>Manuals and user guides:</i>	4
2	QUICK START.....	5
3	CANOPEN INSTALLATION.....	6
3.1	GENERAL.....	6
3.2	CANOPEN CONNECTOR	6
3.3	CANOPEN CABLES AND T-PARTS.....	7
3.4	PHYSICAL SIGNALING.....	7
3.5	NETWORK TERMINATION	7
3.6	NODE-ID	8
3.6.1	<i>Rotary switches</i>	8
3.6.2	<i>Software</i>	8
3.7	DATA RATE	8
3.7.1	<i>Rotary switch</i>	8
3.7.2	<i>Software</i>	8
3.8	LSS.....	9
3.9	NMT STATE MACHINE	9
3.10	HEARTBEAT.....	9
4	INSTRUMENT CONFIGURATION	10
4.1	INSTRUMENT EDS FILE	10
4.2	LOADING EDS FILE	10
4.3	ADD CANOPEN DEVICE TO CONFIGURATION	11
4.4	CONFIGURE PDOs.....	12
4.5	CONFIGURATION PARAMETERS (SDO).....	13
5	OBJECT DESCRIPTION	14
5.1	COMMUNICATION OBJECTS	14
5.1.1	<i>COB IDs</i>	14
5.1.2	<i>Pre-defined Error Field</i>	14
5.1.3	<i>PDO Transfer Types</i>	15
5.1.4	<i>Heartbeat Consumer</i>	15
5.2	MANUFACTURER (PROPAR) OBJECTS.....	15
5.3	PROFILE OBJECTS	16
6	TROUBLESHOOTING	17
6.1	LED INDICATIONS.....	17
6.1.1	<i>RUN LED (GREEN)</i>	17
6.1.2	<i>ERR LED (RED)</i>	17
6.2	BUS DIAGNOSTICS	17
6.3	TROUBLESHOOTING HINTS AND TIPS	18
7	SERVICE	19
	APPENDIX A: OBJECT DICTIONARY	20
	APPENDIX B: SI UNIT AND PREFIX SPECIFICATION	25
	APPENDIX C: NON-SI UNIT SPECIFICATION	26

1 GENERAL PRODUCT INFORMATION

1.1 INTRODUCTION

The CANopen interface offers a direct connection to CANopen Networks for Bronkhorst® digital mass-flow/pressure meters/controllers by supporting the CiA® 404 device profile for measuring devices and closed-loop controllers. This manual is limited to the description of the interface between the CANopen Mass Flow Controller with a master device.

This manual will explain how to install and operate a Bronkhorst® instrument in your CANopen system.



Information about CANopen can be found on the website of the “CAN in Automation” organisation. www.can-cia.org

1.2 REFERENCES TO OTHER APPLICABLE DOCUMENTS

Manuals and guides for digital instruments are modular. General instructions give information about the functioning and installation of instruments. Operational instructions explain the use of the digital instruments features and parameters. Field bus specific information explains the installation and use of the field bus installed on the instrument.

1.2.1 Manuals and user guides:

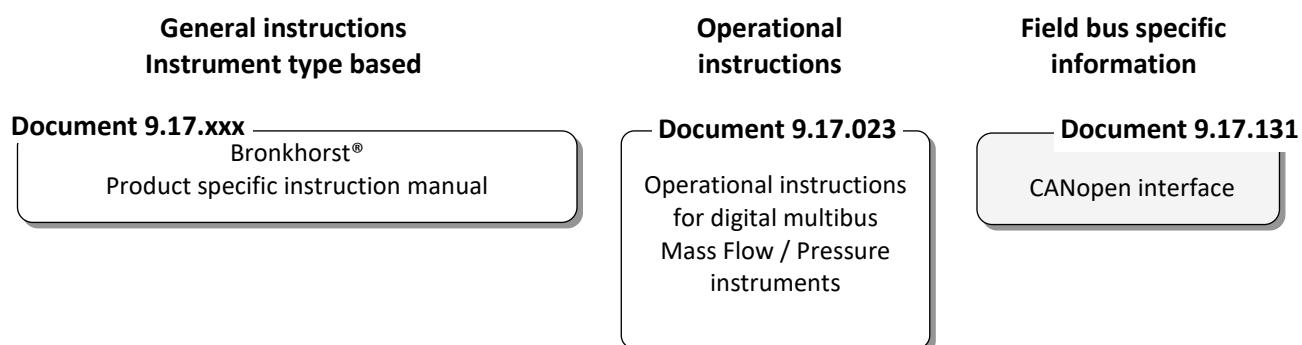

All these documents can be found at:
<http://www.bronkhorst.com/en/downloads>

2 QUICK START

By following these steps, you will quickly get your Bronkhorst CANopen device up and running. The following steps are generalized, and not specific to a type of PLC. For more detail on the steps, see the following chapters or refer to the chapters mentioned in the steps below. These will also show some of these steps with screenshots for CODESYS.

1. Configure the device to the desired Node-ID and data rate, using the rotary switches or software. (see Chapter 3.6 Node-ID and Chapter 3.7 Data rate).
2. Load the Bronkhorst CANopen EDS file (Bronkhorst_Meter_Controller_CANopen.EDS) into the PLC software. Download link: <http://www.bronkhorst.com/int/products/accessories-and-software/flowware/canopen-eds/>
3. Add the Bronkhorst Meter Controller device to the CANopen master in the PLC.
 - Optionally some PLCs offer a scan function to check for devices on the network. This requires a live connection to the PLC, and the instrument should be connected to the CAN interface of the PLC.
4. Set the Node-ID of the Bronkhorst Meter Controller in the PLC configuration to the Node-ID configured in step 1. Also make sure the data rate of the CANopen master matches the data rate configured on the instrument.
5. Enable the heartbeat producer / consumer of the instrument if desired. When the producer is enabled, the master can detect if the instrument loses connection. With the consumer enabled, the instrument can react to losing connection with the master, or another node.
6. Configure the process data objects (PDOs) to contain the desired parameters. The Bronkhorst Meter Controller offers 4 RPDOs and 4 TPDOs with 8 bytes of process data each. By default the first RPDO and TPDO are enabled, configured with default parameters from the CiA® 404 profile for closed loop controllers. The default mapping can be changed.
 - When using the profile objects, it is recommended to not use Propar objects that internally map to the same parameter (and vice versa). See Chapter 5.3 Profile Objects.

Finally setup the transmission type for the PDOs. By default the PDOs will transmit every SYNC (requires the master to be SYNC producer). For a full list of options see Chapter 5.1 Communication Objects.

7. Next setup any parameters that should only be written on initialization. This can usually be found under SDO in your PLC Tool or Master Program. These parameters are written during the configuration of the instrument, before entering operational state. With this mechanism you could for example enable alarm functionality of the instrument, or select the desired fluid.

It is also possible to change these values when the instrument is connected and communicating cyclically. This usually requires PLC programming, and is not within the scope of this manual.

8. With the instrument fully setup in the PLC, build the program and load it into the PLC. Most PLCs will show the actual device parameters in the device overview in the PLC software, once the program is loaded and running. Here you can check that the expected values are received and test operation by forcing values.



Bit 0 of object 0x6425:01 "CO Control Byte" should be 1 to activate the PID controller (bit 0 = controller on/off).

The PID controller is activated by default, but because this object is included in the process data (PDO), the value 0 can be written by the master after entering the operational state.

See APPENDIX A: OBJECT DICTIONARY, description of 0x6425 "CO Control byte"

3 CANOPEN INSTALLATION

3.1 GENERAL

This chapter introduces the CANopen cable system and provides a brief overview of how to set up a CANopen network efficiently. The steps in this chapter describe the basic tasks involved in setting up a network.

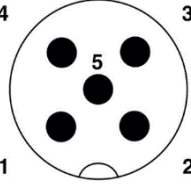
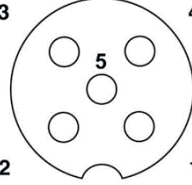

3.2 CANOPEN CONNECTOR

Bronkhorst® instruments are fitted with a micro-style sealed M12-A coded connector.

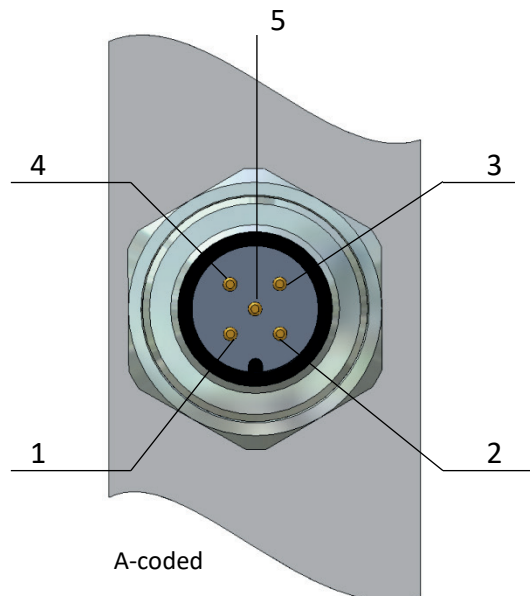
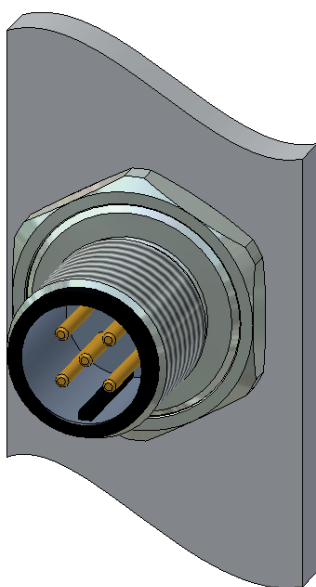
M12 Connector	Male	Female	nr	Color	Wire Identity	Usage Round
			1	Bare	CAN_SHLD	shield
			2	Red	CAN_V+	power
			3	Black	CAN_GND	power
			4	White	CAN_H	signal
			5	Blue	CAN_L	signal

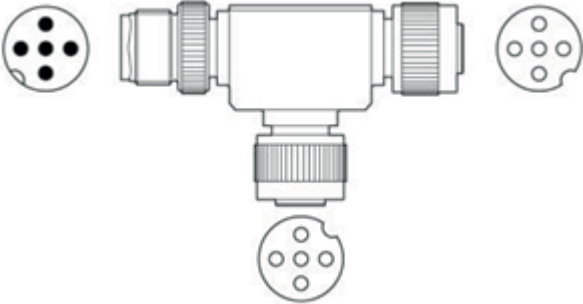
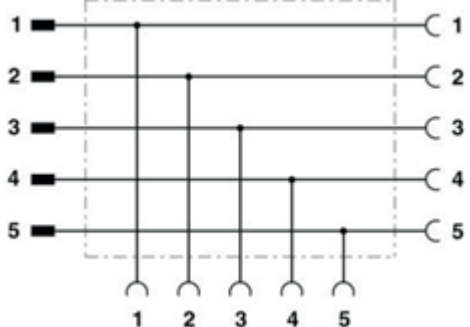

3.3 CANOPEN CABLES AND T-PARTS

M12 cable	M12 termination resistor
	
T-part	T-part wiring
	

3.4 PHYSICAL SIGNALING

CAN physical signaling is defined in CiA® 301.

The table below summarizes the recommended settings and cable lengths for each data rate.

Data rate	Nominal bit time (t_b)	Valid range for location of sample point	Recommended location of sample point	Bus length
1 Mbit/s	1 μ s	75% to 90%	87,5%	25 m
800 Kbit/s	1,25 μ s	75% to 90%	87,5%	50 m
500 Kbit/s	2 μ s	85% to 90%	87,5%	100 m
250 Kbit/s	4 μ s	85% to 90%	87,5%	250 m
125 Kbit/s	8 μ s	85% to 90%	87,5%	500 m
50 Kbit/s	20 μ s	85% to 90%	87,5%	1000 m
20 Kbit/s	50 μ s	85% to 90%	87,5%	2500 m
10 Kbit/s	100 μ s	85% to 90%	87,5%	5000 m

3.5 NETWORK TERMINATION



The CANopen CAN network trunk line must be terminated at both ends with 121 Ohms, 1%, 1/4W terminating resistors.

3.6 NODE-ID

Each device in a CANopen network must have a unique Node-ID. This Node-ID can be set in several ways which are described in the following paragraphs.

3.6.1 Rotary switches

The device supports 2 rotary switches for setting the Node-ID (one digit per rotary switch: MSD and LSD). Using the rotary switches any address between and including 1-79 can be set. To set the address higher than 79, software addressing must be used. When the address is set using the rotary switches, the address cannot be set using software. To set the address using software, the rotary switches must be in the P position.

The new rotary settings will become active after power cycling the instrument.

3.6.2 Software

By default the MSD rotary switch for Node-ID are set into the Programmable (P) position. In this position the Node-ID is software programmable via LSS protocol or Bronkhorst software (Fieldbus1 Address). The newly written Node-ID will become active after a power cycling the instrument, or by the LSS. The maximum value for the software address is 127.

CANopen parameter	Bronkhorst DDE parameter	Default value
Node-ID	199: Fieldbus1 address	127

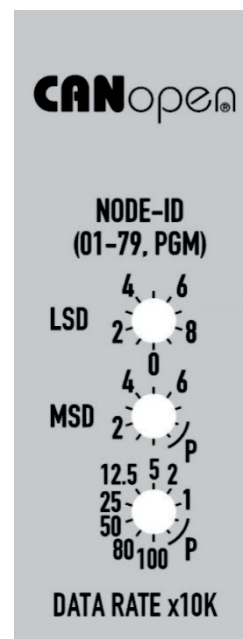

3.7 DATA RATE

3.7.1 Rotary switch

If the CANopen device supports rotary switches, a 10 position rotary switch is used to select the data rate.

The data rate can be set using the bottom rotary switch. The label lists the options as data rate x 10k. Using the rotary switch all data rate options are available from 1Mbit/s to 10kbit/s. The new rotary settings will become active after power cycling the instrument.

The table below shows the supported data rates.

Data rate x 10K	Data rate
100	1 Mbit/s
80	800 Kbit/s
50	500 Kbit/s
25	250 Kbit/s
12.5	125 Kbit/s
5	50 Kbit/s
2	20 Kbit/s
1	10 Kbit/s
P	Software programmable (default is 500 Kbit/s)

3.7.2 Software

By default the rotary switch for data rate is set into the Programmable (P) position. In this position the data rate is software programmable via LSS protocol or Bronkhorst software (Fieldbus1). The newly written data rate will become active after power cycling the instrument, or by the LSS.

CANopen parameter	Bronkhorst DDE parameter	Default value
Data rate	201: Fieldbus1 baudrate	500Kbit/s

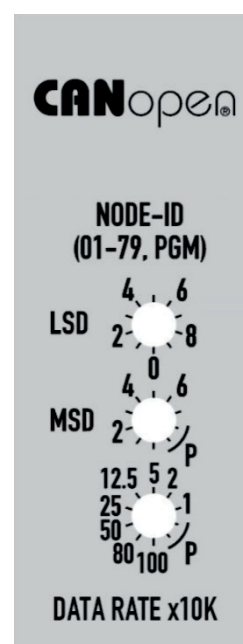

3.8 LSS

In cases where the rotary switches are not accessible or available, LSS can be used to change the Node-ID and data rate of the instrument.

The Node-ID and data rate can only be set via LSS when the rotary switch for the parameter is set to Programmable (P).

For the instrument to respond to LSS configuration messages the instrument must be in the stopped state. In this state the instrument can be put into LSS Configuration mode, using either the selective or global configuration mode command.

Now the Node-ID and data rate can be changed. When the data rate or Node-ID cannot be changed (due to being set with the rotary switch) an error with code 1 is returned. If no error is returned the Node-ID or data rate are stored in the LSS module.

To store the new Node-ID and data rate in the instrument, the LSS store configuration command must be used. This will store the new Node-ID and data rate in the non-volatile area of the instrument. After a power cycle or NMT reset command the instrument will apply the new settings.

Alternately the switch data rate command can be used to switch to the new data rate after a certain delay.

3.9 NMT STATE MACHINE

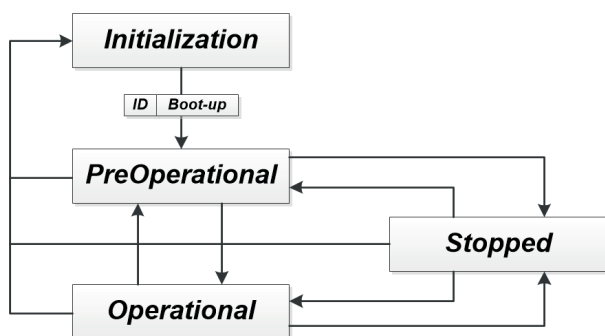

The CANopen NMT state machine effects the operation of the instrument. The Safe State functionality of the instrument is connected to the NMT state.

If the instrument is in the operational state, the Safe State is deactivated. In all other states the instrument will go to Safe State. In Safe State the valve on the instrument will go to the Safe (unpowered) State. In Safe State the instrument will not react to setpoints and Cyclic PDO data will not be updated.

The Instrument must therefore transition to Operational state in order to be operated. This is usually automatically performed by the CANopen master when the instrument is included in the PLC configuration (by the NMT Start node command).

Using the NMT Reset command the stack is restarted and values in the communication object area are reset to power-up defaults.

3.10 HEARTBEAT

Bronkhorst instruments support the heartbeat consumer and heartbeat producer functionality. The heartbeat producer, when enabled, will periodically send a heartbeat message on the network indicating that the instrument is present and functioning.

When the heartbeat consumer is enabled, the instrument will monitor selected nodes on the network, by receiving the heartbeat messages of those nodes. When there have been no heartbeat messages within the set time, the instrument will see this as an error, and move to pre-operational state (which activates the safe state functionality).

4 INSTRUMENT CONFIGURATION

4.1 INSTRUMENT EDS FILE

For operating Bronkhorst CANopen instruments, an EDS file is provided that offers easy access to all objects and configuration parameters available for Bronkhorst instruments. The generic EDS file for Bronkhorst instruments with CANopen, **Bronkhorst_Meter_Controller_CANopen.EDS**, is a text-file which contains information about the options of CANopen interface of the instrument.

In order to make use of the EDS file, it must first be loaded into the PLC software tool. The following chapters will show how to configure a Bronkhorst Meter Controller CANopen instrument using CODESYS. Other PLC software programs are also supported, and largely follow the same procedures. Refer to the manual of your PLC application software for the specifics of the required steps.



The EDS file can be downloaded from the Bronkhorst web-site:

<http://http://www.bronkhorst.com/int/products/accessories-and-software/flowware/canopen-eds/>

4.2 LOADING EDS FILE

Open the “Device Repository” add install the EDS file into the appropriate repository. The device can now be added to a CANopen master in the PLC project via the “Add Device” right-click option on the scanner.

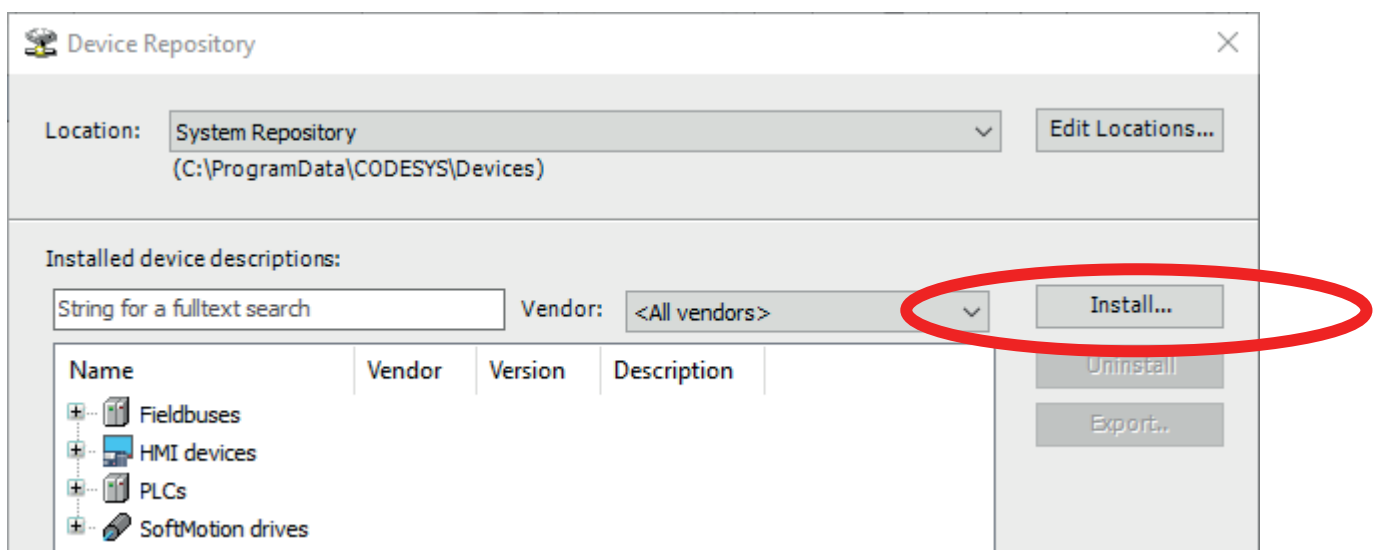

4.3 ADD CANOPEN DEVICE TO CONFIGURATION

Right click the CANopen master and click on Add Device. Select the Bronkhorst Meter Controller and click on Add Device to add the module to the configuration.

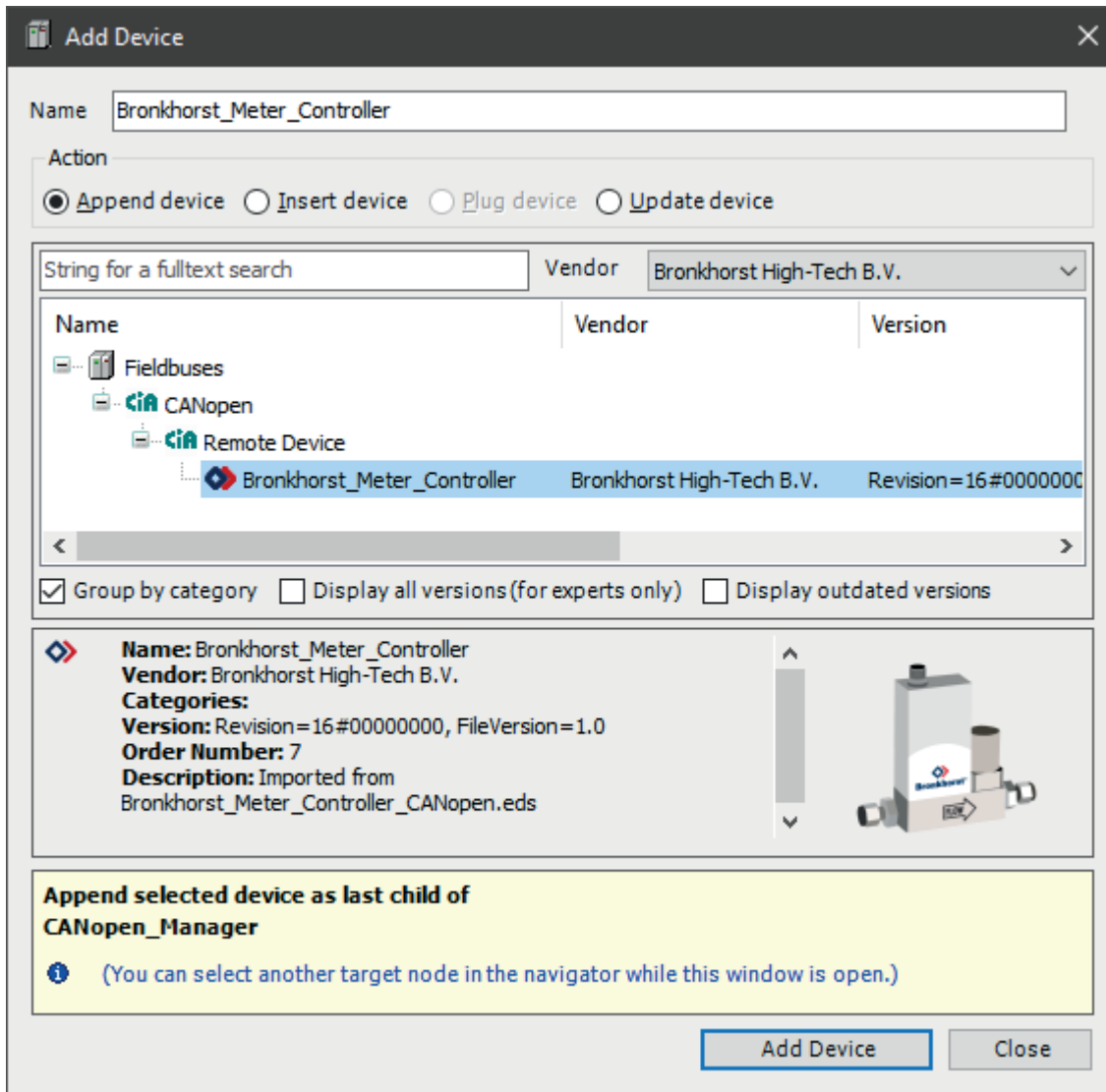

On the device configuration page (shown when double clicking on the added device in the Device tree view), configure the address of the device in the General page.

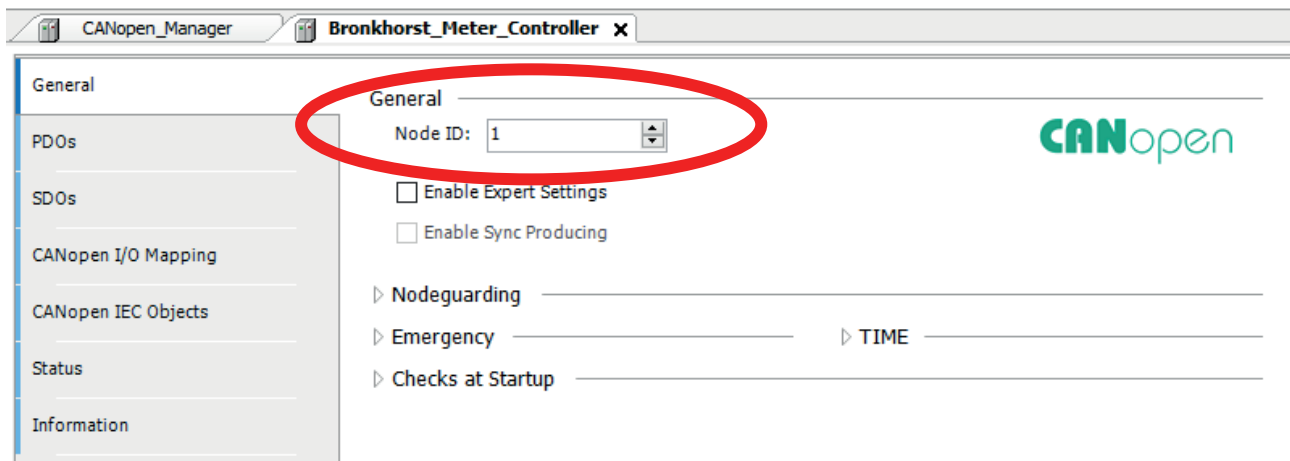

4.4 CONFIGURE PDOs

Configure the PDOs as desired. By default the following items are selected:

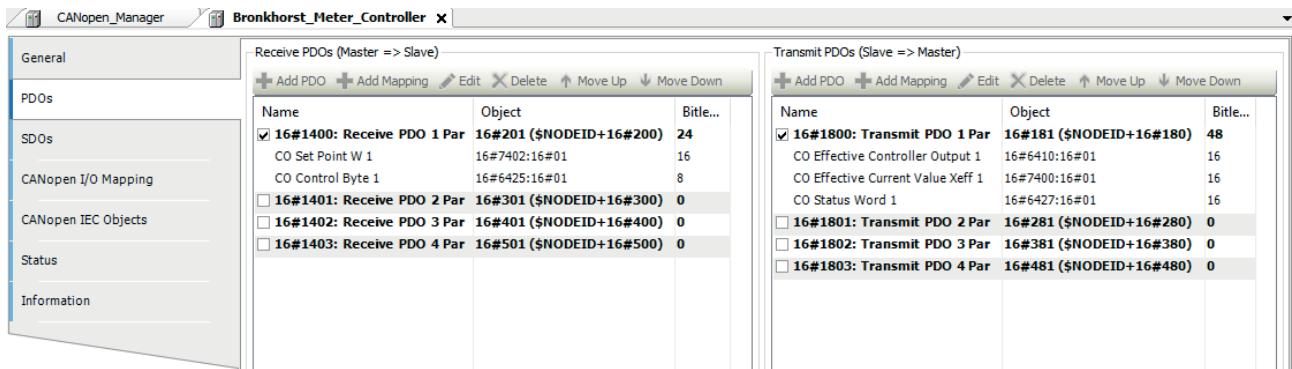

To remove the existing mapping, select an item and click the “Delete” button in the top bar.

To add an item to a mapping, select the desired PDO and click on the “Add Mapping” button in the top bar. In the popup window, select the desired parameter. Click on “OK” to add the parameter to the mapping.

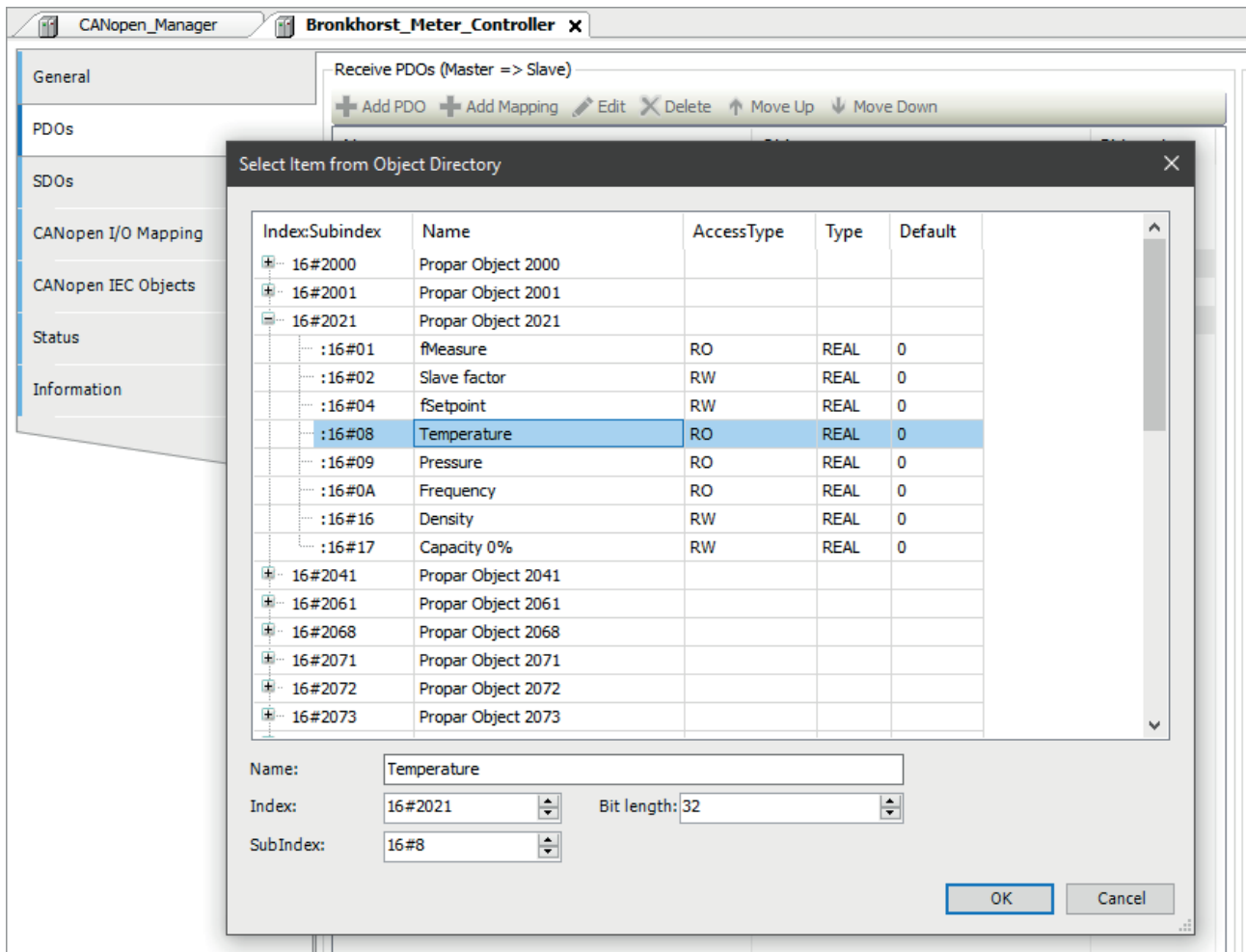

Clicking on the PDO entry will open the PDO properties window. In this window you can set the desired transmission type for this PDO.

For RPDOs this will determine when the PLC will send new data to the instrument.

For TPDOs this will determine when the instrument will sample and send new data to the PLC. For more information about the transfer types, see Chapter 5.1.3 PDO Transfer Types.

PDO Properties

COB-ID:
= 16#301 (769)

Inhibit Time (x 100µs):

Transmission Type:

Number of Syncs:

Event Time (x 1ms):

Process by CANopenManager

4.5 CONFIGURATION PARAMETERS (SDO)

On the Configure SDO tab, parameters can be added that are written when configuring the instrument (before cyclic communication starts and the instrument moves to the operational state). Here you can add parameters that only need to be written once, for example the fluid number or the alarm settings.

It is also possible to write these kind of parameters via SDO when the cyclic communication is active, but this will require programming in the PLC. This is outside the scope of this manual.

Bronkhorst_Meter_Controller

General
PDOs
SDOs
CANopen I/O Mapping
CANopen IEC Objects
Status

+ Add SDO Edit Delete Move Up Move Down

Line	Index:Subindex	Name	Value	Bit length	Comment
1	16#2001:16#11	Fluid number	1	8	

5 OBJECT DESCRIPTION

The CANopen object dictionary can be divided into three parts:

1. Communication area (0x1000 – 0x1FFF)
2. Manufacturer (Propar) area (0x2000 – 0x5FFF)
3. Profile area (0x6000 – 0x9FFF)

The communication area contains CANopen specific objects like the PDO mapping parameters and identity information.

The manufacturer area contains a direct mapping between CANopen objects (index, sub index) to Propar parameters (process, parameter). Offering full access to the parameters available in the instrument.

The profile area contains the parameters of the CiA® 404 profile for measuring devices and closed-loop controllers, providing a standardized interface to this type of instrument.

The next chapters will go over these parts in more detail.

5.1 COMMUNICATION OBJECTS

5.1.1 COB IDs

The COB IDs (CAN message IDs) used for CANopen in Bronkhorst instruments are based on the predefined connection set of CANopen (base COB ID + Node ID), and cannot be changed manually.

The supported COB IDs in the predefined connection set are:

Communication object	COB-ID(s) hex	Slave nodes
NMT node control	0x000	Receive only
SYNC	0x080	Receive only
Emergency	0x080 + Node-ID	Transmit
PDO	0x180 + Node-ID	TPDO1
	0x200 + Node-ID	RPDO1
	0x280 + Node-ID	TPDO2
	0x300 + Node-ID	RPDO2
	0x380 + Node-ID	TPDO3
	0x400 + Node-ID	RPDO3
	0x480 + Node-ID	TPDO4
	0x500 + Node-ID	RPDO4
SDO	0x580 + Node-ID	Transmit
	0x600 + Node-ID	Receive
NMT node monitoring	0x700 + Node-ID	Transmit
LSS	0x7E4	Transmit
	0x7E5	Receive

5.1.2 Pre-defined Error Field

The pre-defined error field contains the last occurred error value (sub index 1), and the number of errors that have occurred (sub index 0). The error counter can be reset by writing 0 to sub index 0.

5.1.3 PDO Transfer Types

The PDOs support the following transfer types:

Value	Transfer Type	Description
0	Acyclic	Transmit on SYNC, only when changed since last SYNC.
1...240	Every nth SYNC	Transmit every nth SYNC. Where n is the transmission type value.
252	RTR SYNC	Build on SYNC, transmit on RTR.
253	RTR	Build and transmit on SYNC.

Transfer types 254 and 255 are not supported.

5.1.4 Heartbeat Consumer

The heartbeat consumer functionality can be used to monitor 4 nodes. To configure the heartbeat consumer, set the appropriate consumer time in sub index 1-4 of object 0x1016. The consumer time value consists of:

Bits	31-24	23-16	15-0
Description	Not used	Node-ID	Time (ms)

When the Node-ID is invalid, the entry is disabled. There can only be one entry for a Node-ID. When a heartbeat consumer timer expires, the instrument will move to pre-operational state, which will also activate the instrument Safe-Safe functionality (value to unpowered state).

5.2 MANUFACTURER (PROPAR) OBJECTS

This area automatically converts all available Propar parameters in the instrument to CANopen objects. The most used parameters are already listed in the EDS file.

In case a parameter is not listed there, the conversion between Propar parameter and CANopen objects is:

CANopen	
Index	Sub Index
0x2000 + parameter nr	0x01 + parameter nr

Examples:

Setpoint

Propar
Process 1, Parameter 1
=
CANopen
Index 0x2001, Sub Index 0x02

Valve Output

Propar
Process 114, Parameter 1
=
CANopen
Index 0x2072, Sub Index 0x02



Detailed information on Propar can be found in:
"Operation instructions digital instruments" (document nr. 9.17.023).
http://www.bronkhorst.com/en/downloads/instruction_manuals/

5.3 PROFILE OBJECTS

Bronkhorst instruments support the mandatory objects from the controller function block from CiA® 404 V1.2, *Measurement Devices and Closed Loop Controllers*. These objects (0x6400 – 0x7405) are also listed in Appendix A: Object Dictionary

Object 0x6406 contains a representation of the unit for current value and setpoint. This representation only contains SI units (see Appendix B: SI Unit AND Prefix Specification). Bronkhorst instruments support a lot of non-SI units, which are described in Appendix C: Non-SI Unit Specification.

The unit is represented by an unsigned32 value with the following meaning:

Prefix		Numerator		Denominator		reserved	
31	24	23	16	15	8	7	0

Examples:

kg/s is represented by

Prefix		Numerator		Denominator		reserved	
0x00		0x02		0x03		0x00	

with

Prefix = 0x00	means no prefix
Numerator = 0x02	means kg
Denominator = 0x03	means s

mln/min is represented by

Prefix		Numerator		Denominator		reserved	
0xFD		0xC0		0x47		0x00	

with

Prefix = 0xFD	means 10^{-3} = milli
Numerator = 0xC0	means ln
Denominator = 0x47	means min

6 TROUBLESHOOTING

6.1 LED INDICATIONS

Bronkhorst CANopen devices support 2 single color LEDs as indicators. The LEDs statuses are specified in CiA® 303.

6.1.1 RUN LED (GREEN)

	State	Description
Flickering	LSS	LSS is in configuration mode (alternately flickering with ERR LED)
Blinking	Pre-Operational	The device is in state PRE-OPERATIONAL
Single flash	Stopped	The device is in state STOPPED
On	Operational	The device is in state OPERATIONAL

6.1.2 ERR LED (RED)

	State	Description
Off	No Error	The device is in working condition
Flickering	LSS	LSS is in configuration mode (alternately flickering with RUN LED)
Blinking	Invalid Configuration	General configuration error
Single flash	Warning limit reached	CAN controller error limit
Double flash	Heartbeat error	No heartbeat received (consumer)
On	Bus off	The CAN controller is bus off

6.2 BUS DIAGNOSTICS

The Fieldbus1 Diagnostics parameter offers diagnostic information about the CANopen interface on the instrument. This parameter is available in FlowDDE (parameter nr 202), or via Propar (process 125, parameter 20, parameter type String).

SnnNnnInnBnnRnn	
Part	Description
S	Stack state
N	Network state
I	Node ID
B	Data rate
R	Rotary switch active (Node-ID 0/1, data rate 0/1)

6.3 TROUBLESHOOTING HINTS AND TIPS

Symptom	Possible cause	Action
Instrument does not react to setpoint	Instrument not in operational state	Set instrument to operational state using NMT commands
	CO Control Byte not set to activate controller (this parameter is mapped by default)	Set the CO Control Byte to 1 to activate the controller (this is only required when the CO Control Byte is configured in an RPDO)
No communication with the instrument	Invalid data rate on instrument	Set the correct data rate on the instrument or the network
	Duplicate Node-ID on the network	Set the Node-IDs so that there are no duplicate addresses
Unstable communication or continuously restarting nodes	Invalid heartbeat consumer configuration	Make sure that the consumer time is at least the producer time + 100ms.
	Bus load too high	Make sure that the data transferred each SYNC does not exceed the SYNC cycle time, and that the SYNC window leaves enough time for acyclic communication (target should be around 75% for cyclic, with 25% remaining for acyclic messaging).

7 SERVICE

For current information on Bronkhorst® and service addresses please visit our website:

 <http://www.bronkhorst.com>

Do you have any questions about our products? Our Sales Department will gladly assist you selecting the right product for your application. Contact sales by e-mail:

 sales@bronkhorst.com

For after-sales questions, our Customer Service Department is available with help and guidance. To contact CSD by e-mail:

 support@bronkhorst.com

No matter the time zone, our experts within the Support Group are available to answer your request immediately or ensure appropriate further action. Our experts can be reached at:

 **+31 859 02 18 66**

APPENDIX A: OBJECT DICTIONARY

Index	Sub Index	Description	Data Type	Access	PDO mapping
0x1000		Device Type	Unsigned32	RO	No
0x1001		Error Register	Unsigned8	RO	No
0x1003		Pre-defined Error Field			
	0	Number of Errors	Unsigned8	RW	No
	1	Standard Error Field	Unsigned32	RO	No
0x1005		SYNC COB ID	Unsigned32	RO	No
0x1008		Manufacturer Device Name	Visible String	RO	No
0x100A		Manufacturer Software Version	Visible String	RO	No
0x1011		EMCY COB ID	Unsigned32	RO	No
0x1016		Consumer Heartbeat Time			
	0	Number of Entries	Unsigned8	RO	No
	1	Consumer Heartbeat Time 1	Unsigned32	RW	No
	2	Consumer Heartbeat Time 2	Unsigned32	RW	No
	3	Consumer Heartbeat Time 3	Unsigned32	RW	No
	4	Consumer Heartbeat Time 4	Unsigned32	RW	No
0x1017		Producer Heartbeat Time	Unsigned16	RW	No
0x1018		Identity			
	0	Number of Entries	Unsigned8	RO	No
	1	Vendor ID ⁴	Unsigned32	RO	No
	2	Product Code	Unsigned32	RO	No
	3	Revision Number	Unsigned32	RO	No
	4	Serial Number	Unsigned32	RO	No
0x1200		SDO COB IDs			
	0	Number of Entries	Unsigned8	RO	No
	1	COB ID Client to Server	Unsigned32	RO	No
	2	COB ID Server to Client	Unsigned32	RO	No
0x1400		RPDO Parameters			
0x1401	0	Number of Entries	Unsigned8	RO	No
0x1402	1	COB ID	Unsigned32	RW	No
0x1403	2	Transmission Type	Unsigned8	RW	No
	6	Sync Start Value	Unsigned16	RW	No
0x1600		RPDO Mapping			
0x1601	0	Nr of mapped items	Unsigned8	RO	No
0x1602	1	Mapped Object 1	Unsigned32	RO	No
0x1603	2...6	Mapped Object 2 to 6			
	8	Mapped Object 8	Unsigned32	RO	No
0x1800		TPDO Parameters			
0x1801	0	Number of Entries	Unsigned8	RO	No
0x1802	1	COB ID	Unsigned32	RW	No
0x1803	2	Transmission Type	Unsigned8	RW	No
	6	Sync Start Value	Unsigned16	RW	No
0x1A00		TPDO Mapping			

⁴ Bronkhorst Vendor ID is 1189 (0x000004A5)

Index	Sub Index	Description	Data Type	Access	PDO mapping
0x1A01	0	Nr of mapped items	Unsigned8	RO	No
0x1A02	1	Mapped Object 1	Unsigned32	RO	No
0x1A03	2...6	Mapped Object 2 to 6			
	8	Mapped Object 8	Unsigned32	RO	No
0x6403	0	Number of Entries	Unsigned8	RO	No
	1	CO 2 nd Setpoint W2	Float	RW	Possible
0x6404	0	Number of Entries	Unsigned8	RO	No
	1	CO Lower setpoint limit W0	Float	RO	No
0x6405	0	Number of Entries	Unsigned8	RO	No
	1	CO Upper setpoint limit W100	Float	RO	No
0x6406	0	Number of Entries	Unsigned8	RO	No
	1	CO Physical unit current value / setpoint	Unsigned32	RW	No
0x6407	0	Number of Entries	Unsigned8	RO	No
	1	CO Decimal digits current value / setpoint	Unsigned8	RW	No
0x6410	0	Number of Entries	Unsigned8	RO	No
	1	CO Effective controller output Y	Unsigned16	RO	Possible
0x6415	0	Number of Entries	Unsigned8	RO	No
	1	CO Physical unit controller output	Unsigned32	RO	No
0x6420	0	Number of Entries	Unsigned8	RO	No
	1	CO Setpoint switch W/W2	Boolean	RW	No
0x6421	0	Number of Entries	Unsigned8	RO	No
	1	CO Automatic / manual mode A/M	Boolean	RW	No
0x6422	0	Number of Entries	Unsigned8	RO	No
	1	CO Controller on / off	Boolean	RW	No
0x6423	0	Number of Entries	Unsigned8	RO	No
	1	CO Controller mode	Unsigned8	RW	Possible
0x6425	0	Number of Entries	Unsigned8	RO	No
	1	CO Control byte	Unsigned8	RW	Possible
0x6427	0	Number of Entries	Unsigned8	RO	No
	1	CO Status word	Unsigned16	RO	Possible
0x7400	0	Number of Entries	Unsigned8	RO	No
	1	CO Effective current value Xeff (INT)	Unsigned16	RW	Possible
0x7401	0	Number of Entries	Unsigned8	RO	No
	1	CO Effective setpoint Weff (INT)	Unsigned16	RO	Possible
0x7402	0	Number of Entries	Unsigned8	RO	No
	1	CO Setpoint W (INT)	Unsigned16	RW	Possible
0x7403	0	Number of Entries	Unsigned8	RO	No
	1	CO 2 nd Setpoint W2 (INT)	Unsigned16	RW	Possible

Index	Sub Index	Description	Data Type	Access	PDO mapping
0x7404	0	Number of Entries	Unsigned8	RO	No
	1	CO Lower setpoint limit W0 (INT)	Unsigned16	RO	No
0x7405	0	Number of Entries	Unsigned8	RO	No
	1	CO Upper setpoint limit W100 (INT)	Unsigned16	RO	No

Object 0x6410: CO Effective controller output Y

hexadecimal value	decimal value	percent value
0xFC18	-1000	-100.0%
:::	:::	:::
0xFE0C	-500	-50.0%
:::	:::	:::
0x0000	0	0.0%
:::	:::	:::
0x1F4	500	50.0%
:::	:::	:::
0x3E8	1000	100.0%

0x6422 CO Control On/Off

control byte	Mode
TRUE	DDE parameter 12 control mode = 0 (controller active)
FALSE	DDE parameter 12 control mode = 12 (setpoint 0%)

0x6423 CO Controller mode

control byte	Mode
0x80	manufacturer specific controller type
:::	:::
0xFF	manufacturer specific controller type

Bronkhorst instruments only support range 0x80h – 0x96. It is used as follows:

0x80: DDE parameter 12 control mode = 0
 0x81: DDE parameter 12 control mode = 1
 0x82: DDE parameter 12 control mode = 2
 Etc.

Essential control modes:

Nr.	Mode	Instrument action
0	Controlling	Control at setpoint value
3	Valve closed	No controller action, valve is closed
4	Controller Idle	No controller action, valve remains its position
8	Valve purge	No controller action, valve is fully open



More available control modes can be found in
 "Operation instructions digital instruments" (document nr. 9.17.023).
http://www.bronkhorst.com/en/downloads/instruction_manuals/

0x6425 CO Control byte

MSB				LSB	
Reserved	Setpoint switch	Manual Mode	Self-optimization	Controller on / off	
7 ... 4	3	2	1	0	

Value	Meaning
0	disable function
1	enable function

Self- optimization is not supported (is always 0)

0x6427 CO Status word

MSB					LSB				
reserved	Net overload	Over-load	Data not valid	reserved	Optimization error	Setpoint switch	Manual Mode	Self-optimization	Controller on / off
15 ... 11	10	9	8	7 ... 5	4	3	2	1	0

Value	Meaning
0	not valid (not occurred)
1	valid (occurred)

The following objects are mapped to the following DDE parameters:

Index	Sub Index	Description	DDE parameter
0x6400	1	CO Effective current value Xeff	fMeasure / Measure
0x6401	1	CO Effective setpoint Weff	fSetpoint / Setpoint
0x6402	1	CO Setpoint W	fSetpoint / Setpoint
0x6404	1	CO Lower setpoint limit W0	Capacity 0% (read only)
0x6405	1	CO Upper setpoint limit W100	Capacity (read only)
0x6410	1	CO Effective controller output Y	Valve output (scaled to % as described above)
0x6422	1	CO Controller on / off	- (is described above)
0x6423	1	CO Controller mode	Control mode
0x6425	1	CO Control byte	- (is described above)
0x6425	1	CO Status word	- (is described above)
0x7400	1	CO Effective current value Xeff (INT)	fMeasure / Measure ⁵
0x7401	1	CO Effective setpoint Weff (INT)	fSetpoint / Setpoint ⁵
0x7402	1	CO Setpoint W (INT)	fSetpoint / Setpoint ⁵
0x7404	1	CO Lower setpoint limit W0 (INT)	Capacity 0% (read only) ⁵
0x7405	1	CO Upper setpoint limit W100 (INT)	Capacity (read only) ⁵



The value of object 0x6407:01 CO Decimal digits current value / set point is determined and optimized automatically during instrument power-up.

⁵ Examples:

fMeasure = 1.15 ln/min

object 0x6407:01 CO Decimal digits current value / set point = 3

object 0x7401:01 CO Effective current value Xeff = $1.15 \times (10 \times 10 \times 10) = 1150$

object 0x6407:01 CO Decimal digits current value / set point = 4

object 0x7402:01 CO Setpoint W (INT) = 22500

fSetpoint = $22500 / (10 \times 10 \times 10 \times 10) = 2.25$ ln/min

⁵ Integer16 value scaled with the value of object 0x6407:01

⁵ Integer16 value scaled with the value of object 0x6407:01

APPENDIX B: SI UNIT AND PREFIX SPECIFICATION

SI Unit Specification				
Name	Symbol	Notation index (hex)	Index	Description
Kilogram	kg	0x02	0x402	Mass
Second	s	0x03	0x403	Time
Kelvin	K	0x05	0x405	Temperature
Pascal	Pa	0x22	0x422	Pressure
Degree Celsius	°C	0x2D	0x42D	Temperature
Liter	l	0x44	0x444	Volume
Minute	min	0x47	0x447	Time
Hour	h	0x48	0x448	Time
Bar	bar	0x4E	0x44E	Pressure
Cubic meter	m ³	0x59	0x459	Volume

Prefix Specification			
Prefix	Symbol	Factor	Notation Index
<i>reserved</i>	-	-	<i>0x13 – 0x7F</i>
exa	E	10 ¹⁸	0x12
		10 ¹⁷	0x11
		10 ¹⁶	0x10
peta	P	10 ¹⁵	0x0F
		10 ¹⁴	0x0E
		10 ¹³	0x0D
tera	T	10 ¹²	0x0C
		10 ¹¹	0x0B
		10 ¹⁰	0x0A
giga	G	10 ⁹	0x09
		10 ⁸	0x08
		10 ⁷	0x07
mega	M	10 ⁶	0x06
		10 ⁵	0x05
		10 ⁴	0x04
kilo	k	10 ³	0x03
hecto	h	10 ²	0x02
deca	da	10 ¹	0x01
		10 ⁰	0x00
deci	d	10 ⁻¹	0xFF
centi	c	10 ⁻²	0xFE
milli	m	10 ⁻³	0xFD
		10 ⁻⁴	0xFC
		10 ⁻⁵	0xFB
micro	μ	10 ⁻⁶	0xFA
		10 ⁻⁷	0xF9
		10 ⁻⁸	0xF8
nano	n	10 ⁻⁹	0xF7
		10 ⁻¹⁰	0xF6
		10 ⁻¹¹	0xF5
pico	p	10 ⁻¹²	0xF4
		10 ⁻¹³	0xF3
		10 ⁻¹⁴	0xF2
femto	f	10 ⁻¹⁵	0xF1
		10 ⁻¹⁶	0xF0
		10 ⁻¹⁷	0xEF
atto	a	10 ⁻¹⁸	0xEE
<i>reserved</i>	-	-	<i>0xED – 0x80</i>

APPENDIX C: NON-SI UNIT SPECIFICATION

Name	Symbol	Notation index (hex)	Index	Description
gram-force per square centimeter	gf/cm ²	0xA0	0x4A0	pressure
pound-force per square inch	psi	0xA1	0x4A1	pressure
torr pressure	torr	0xA2	0x4A2	pressure
standard atmosphere pressure	atm	0xA3	0x4A3	pressure
meter of water pressure	mH ₂ O	0xA4	0x4A4	pressure
inch of water pressure	``H ₂ O	0xA5	0x4A5	pressure
feet of water pressure	ftH ₂ O	0xA6	0x4A6	pressure
meter of mercury pressure	mHg	0xA7	0x4A7	pressure
inch of mercury pressure	``Hg	0xA8	0x4A8	pressure
cubic centimeter	cc	0xB0	0x4B0	volume
cubic millimeter	mm ³	0xB1	0x4B1	volume
cubic centimeter	cm ³	0xB2	0x4B2	volume
cubic foot per hour	cfh	0xB3	0x4B3	volume
cubic foot per minute	cfm	0xB4	0x4B4	volume
cubic foot per second	cfs	0xB5	0x4B5	volume
liter (normal)	ln	0xC0	0x4C0	volume (normal flow)
cubic centimeter (normal)	ccn	0xC1	0x4C1	volume (normal flow)
cubic millimeter (normal)	mm ³ n	0xC2	0x4C2	volume (normal flow)
cubic centimeter (normal)	cm ³ n	0xC3	0x4C3	volume (normal flow)
cubic meter (normal)	m ³ n	0xC4	0x4C4	volume (normal flow)
standard cubic foot per hour	scfh	0xC5	0x4C5	volume (normal flow)
standard cubic foot per minute	scfm	0xC6	0x4C6	volume (normal flow)
standard cubic foot per second	scfs	0xC7	0x4C7	volume (normal flow)
standard cubic centimeter per minute	sccm	0xC8	0x4C8	volume (normal flow)
standard liter per minute	slm	0xC9	0x4C9	volume (normal flow)
liter (standard)	ls	0xD0	0x4D0	volume (standard flow)
cubic centimeter (standard)	ccs	0xD1	0x4D1	volume (standard flow)
cubic millimeter (standard)	mm ³ s	0xD2	0x4D2	volume (standard flow)
cubic centimeter (standard)	cm ³ s	0xD3	0x4D3	volume (standard flow)
cubic meter (standard)	m ³ s	0xD4	0x4D4	volume (standard flow)